

FECHAMENTO SOB A ESCADA EM MDF
18mm COM PORTAS E PUXADORES
esc.: 1/25

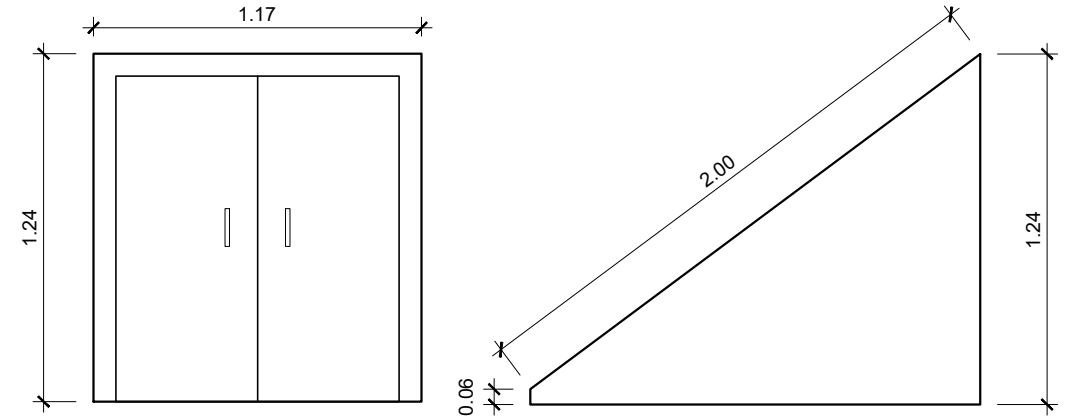

PLANTA

FECHAMENTO LATERAL

ARMÁRIO SOB JANELA EM MDF
18mm COM PORTAS E PUXADORES
esc.: 1/25

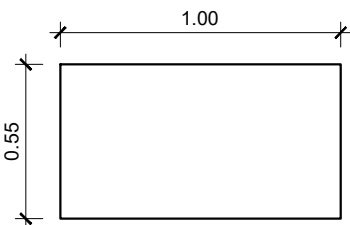

PLANTA

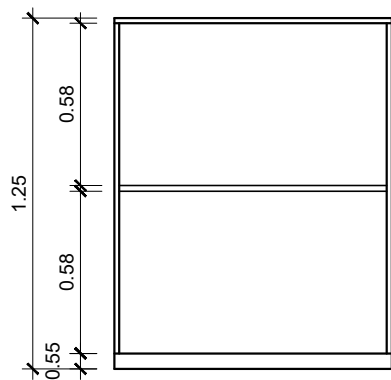

VISTA FRONTAL

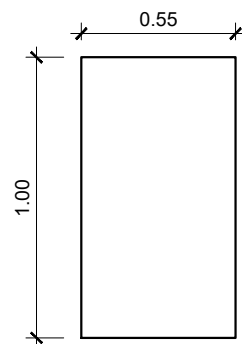

VISTA LATERAL

ARMÁRIO EM MDF 18mm COM PORTAS
E PUXADORES
esc.: 1/25

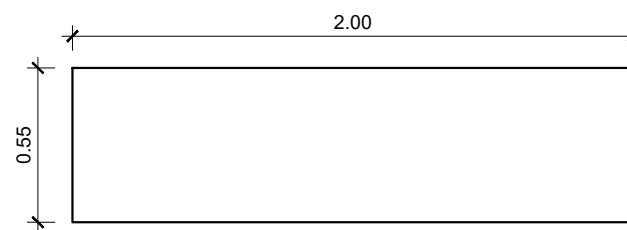

PLANTA

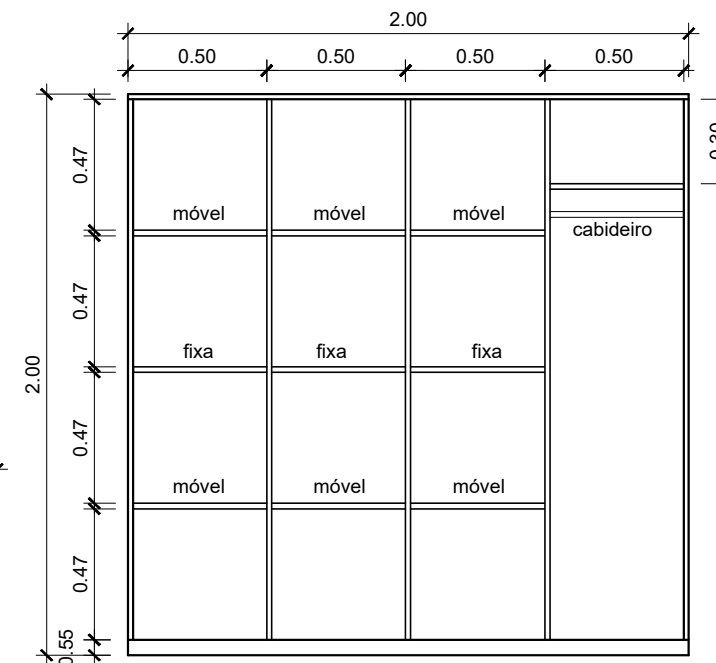

VISTA FRONTAL

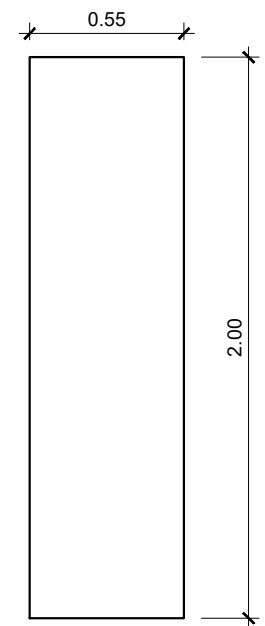

VISTA LATERAL

Responsável:
SECRETARIA MUNICIPAL DE PLANEJAMENTO TRANSPORTE E OBRAS
SERVIÇO DE PLANEJAMENTO URBANÍSTICO E HABITAÇÃO

Gestão:
RUBENS BLASZKOWSKI
Prefeito Municipal de Campo Alegre

Solicitante:
FUNREBOM

Projeto:
FABIANO BICALHO
Arquiteto



PREFEITURA MUNICIPAL DE CAMPO ALEGRE - SC

Título:
MOBILIÁRIO - OBM DE CAMPO ALEGRE

fase:
AP

data:
03/08/2020

escala:
indicada

prancha:

01

01